

Metal Bldg.  
Sales &  
Erection

Structural  
Steel  
Erections



C-Iron

Tubing

Sheets

Trim

## ***Two Locations To Serve Your Needs***

### **Store Hours**

8:00 a.m. - 5:30 p.m. Monday – Friday



### Branch Sale Location

## **Childress Branch**

3200 Ave. F. Northwest  
Childress, TX 79201  
Telephone 940-937-2337  
1-866-896-2337  
Fax 940-937-2379

### Corporate Office and Sales

## **Seymour Branch**

164 US Hwy 283 S.  
Seymour, TX 76380  
Telephone 940-888-1830  
1-800-699-4042  
Fax 940-888-3332



*Prices subject to change without notice  
Not all items stocked in each store*



## **Company Policies**

### **Returned Material Policy**

On all refunds, the material must be returned in the original condition and accompanied with the sales receipt within 45 days of the date of purchase. The condition of the material returned will be determined by Snyder Steel Sales Company.

### **Stocking & Pricing Policy**

Some products listed in the catalog are not kept in stock at all times. Due to market fluctuations, prices are subject to change without notice. Please call to verify pricing and availability. If you have an inquiry on products not listed, please call. If they are not in stock we would like to special order them for you.

### **Delivery Service**

Snyder Steel Sales Company offers a delivery service to its customers. Please call for pricing.

### **Storage Policy**

All orders on stock products must be picked up, or arrangements made for delivery, within ten (10) days from the date of order. After this time the material will be placed back into stock unless other arrangements have been made with your sales representative. Custom orders must be picked up within 30 days from the date of arrival. After that, there will be a \$1/day storage charge.

### **Special Order Policy**

A 20% deposit will be required on any special order products.

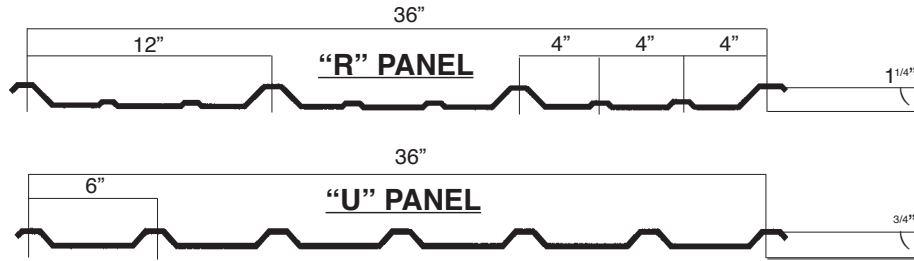

## Premium (25 & 40 Year) Material

(Wide color selection, custom orders only.)

All Sheets are Priced per 100 Square Feet

40 Yr. Warranty Colored	26 ga. 80,000 p.s.i.	White, Tan, Light Stone or Ash Gray .....	\$83.95 sq.
40 Yr. Warranty Colored	26 ga. 80,000 p.s.i.	Koko Brown, Hawaiian Blue, Colonial Red, Crimson Red, Aztec Gold, Steel Gray, Burnished Slate, Colony Green, Fern Green, Surfsand, Old Town Gray, Burgandy, Patina Green or Aspen Green .....	\$88.95 sq.
25 Yr. Warranty Galvalume Plus	26 ga. 80,000 p.s.i.	.....	\$72.50 sq.

All above Panels come in PBR & PCU

## Quality (20 Year) Material

All Sheets are Priced per 100 Square Feet

20 Yr. Warranty	26 ga. 80,000 p.s.i.	White, Tan, Light Stone or Ash Gray .....	\$78.95 sq.
-----------------	----------------------	---	-------------

Stock Colors:  
White & Galvalume

We have a variety of different profiles, gauges and colors available.  
Please inquire for stock sizes of quality grade material and availability of stock in secondary materials.  
If we don't have the product in stock, we would like to order it for you.

*Prices subject to change without notice*

# Structural Steel

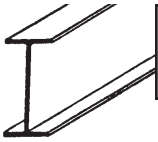

## #1 Wide Flange Beam

- 6" x 4" x 9# (Stock)
- 6" x 6" x 15#
- 8" x 4" x 10# (Stock)
- 8" x 4" x 15#
- 8" x 5 1/4" x 18#
- 10" x 4" x 12# (Stock)
- 10" x 4" x 17#
- 12" x 4" x 14# (Stock)
- 12" x 4" x 16#
- 12" x 4" x 19#
- 14" x 5" x 22#
- 16" x 5 1/2" x 26#
- 18" x 6" x 35#
- 21" x 6 1/2" x 44#

*Due to market fluctuations, please call for current pricing.*



## Square Tubing

**Black    Painted**

- 1/2" x 1/2" x 16 ga.
- 3/4" x 3/4" x 16 ga.
- 3/4" x 3/4" x 14 ga.
- 1" x 1" x 14 ga.            24'
- 1" x 1" x 11 ga.
- 1 1/4" x 1 1/4" x 14 ga.    20' & 24'
- 1 1/4" x 1 1/4" x 11 ga.
- 1 1/2" x 1 1/2" x 14 ga.    20' & 24'
- 1 1/2" x 1 1/2" x 11 ga.
- 2" x 2" x 14 ga.            20' & 24'
- 2" x 2" x 11 ga.            24'
- 2" x 2" x 3/16"
- 2" x 2" x 1/4"
- 2 1/2" x 2 1/2" x 14 ga.
- 2 1/2" x 2 1/2" x 11 ga.
- 3" x 3" x 14 ga.            20' & 24'
- 3" x 3" x 11 ga.
- 3" x 3" x 3/16"
- 3" x 3" x 1/4"
- 4" x 4" x 14 ga.            20' & 24'
- 4" x 4" x 11 ga.            20' & 24'
- 4" x 4" x 3/16"
- 4" x 4" x 1/4"

*Due to market fluctuations, please call for current pricing.*



## "C" Purlin - Painted

All 14 gauge

- 3" x 1 1/2" ..... 20'-30'
- 4" x 1 1/2" ..... 20'-25'-30'
- 6" x 2" ..... 20'-25'-30'
- 8" x 2 1/2" ..... 20'-25'-30'
- 10" x 2 3/4" ..... 30'

*Due to market fluctuations, please call for current pricing.*



## Rectangular Tubing

**Black    Painted**

- 1" x 2" x 14 ga.            24'
- 1 1/2" x 3" x 14 ga.        20' & 24'
- 2" x 3" x 14 ga.
- 2" x 4" x 14 ga.            20' & 24'
- 2" x 6" x 14 ga.
- 2" x 6" x 11 ga.

*Due to market fluctuations, please call for current pricing.*

## Purlin Clips

- 3" x 5" x 10 ga. .... 59¢ ea.
- 5" x 7" x 3/15" ..... \$1.19 ea.

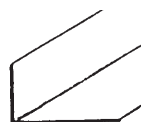

## Rake & Base Angle

Painted - 20' or 25'

- 4" x 2" x 14 ga.
- 2" x 2" x 14 ga.

*Due to market fluctuations, please call for current pricing.*



## Flat Strap

- 1" x 1/8" x 20'
- 2" x 1/8" x 20'
- 3" x 1/8" x 20'
- 4" x 1/8" x 20'
- 6" x 1/8" x 20'
- 1" x 1/4" x 20'
- 2" x 1/4" x 20'
- 3" x 1/4" x 20'
- 3 1/2" x 1/4" x 20'
- 4" x 1/4" x 20'
- 6" x 1/4" x 20'
- 8" x 1/4" x 20'
- 2" x 3/8" x 20'
- 3" x 3/8" x 20'
- 4" x 3/8" x 20'
- 6" x 3/8" x 20'
- 2" x 1/2" x 20'
- 4" x 1/2" x 20'
- 6" x 1/2" x 20'
- 8" x 1/2" x 20'
- 6" x 3/4" x 20'
- 3" x 1" x 20'

*Due to market fluctuations, please call for current pricing.*



## Angle Iron

- 1" x 1" x 1/8" x 20'
- 1 1/2" x 1 1/2" x 1/8" x 20'
- 2" x 2" x 1/8" x 20'
- 2" x 2" x 3/16" x 20'
- 2 1/2" x 2 1/2" x 3/16" x 20'
- 3" x 3" x 3/16" x 20'
- 2" x 2" x 1/4" x 20'
- 2" x 3" x 1/4" x 20'
- 3" x 3" x 1/4" x 20'
- 4" x 4" x 1/4" x 20'
- 2" x 2" x 3/8" x 20'
- 3" x 3" x 3/8" x 20'

*Due to market fluctuations, please call for current pricing.*

## Flat Sheets

- 4' x 8' x 16 ga.
- 4' x 8' x 12 ga.
- 4' x 8' x 10 ga.

*Due to market fluctuations, please call for current pricing.*

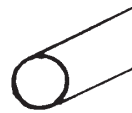

## Round Tubing

- 3/4" Black
- 1" Black
- 1 7/8" x 24' 14 ga.
- 2 3/8" x 32' sch. 40
- 2 3/8" Used Structural
- 2 7/8" Used Structural
- 3 1/2" Used Structural

*Due to market fluctuations, please call for current pricing.*

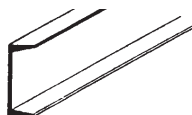

## Channel Iron

- 3" x 4.1#
- 4" x 5.4#
- 6" x 8.2#
- 8" x 11.5#

*Due to market fluctuations, please call for current pricing.*

## Dome Pipe Caps

- 2 3/8" Dome Pipe Caps ..... \$1.70 ea.
- 2 7/8" Dome Pipe Caps ..... \$1.90 ea.
- 3 1/2" Dome Pipe Caps ..... \$2.30 ea.
- 4 1/2" Dome Pipe Caps ..... \$2.90 ea.

# Structural Steel & Building Accessories



Flattened



Standard

## Expanded Metal

4' x 8' Sheets

- 3/4" x #9 Flat
- 3/4" x #9 Std.
- 3/4" x #10 Flat
- 1 1/2" x #10 Std.
- 1/2" x #16 Flat
- #3 Grating

*Due to market fluctuations, please call for current pricing.*

## Rebar

- 3/8" x 20'
- 1/2" x 20'
- 5/8" x 20'

*Due to market fluctuations, please call for current pricing.*

## 16 Ga. Steel Culvert Pipe

- 12" x 20' & 24'
- 18" x 20' & 24'
- 24" x 20' & 24'
- Design 3 x 20
- 18" Band
- 24" Band

*Due to market fluctuations, please call for current pricing.*

## Self Drill Screws

	Each	Plated & Painted Per Bag
<b>Tekscrews (Self Drillers)</b>		
#12" X 3/4"	08¢	\$8.00
#12 X 1 1/4"	09¢	\$9.00
<b>Wood Binders</b>		
#10 X 1"	05¢	\$5.00
#10 X 1 1/2"	06¢	\$6.00
#10 X 2 1/2"	08¢	\$8.00
Lap Tek	#14 x 7/8	08¢ \$8.00
<b>(All Galvalume Screws Are .01¢ Less)</b>		
Max Drills	#12-24 X 1 1/4"	12¢ \$12.00
<b>Phillips Wafer Head - Ply Metals</b>		
	#10 X 1 7/16"	08¢ \$8.00
	#12 X 2"	12¢ \$12.00
	#12 X 2 1/2"	15¢ \$15.00

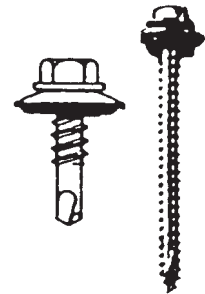

\* Screws are packaged 100 pieces per bag.

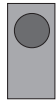

Kit includes door, frame, lockset, hinges and threshold. 6' x 7' kit includes one 8" surface bolt and 2-3' x 7' doors.

Doors Are White With Embossed Finish

Door Size	Door Price	Frame Size	Frame Price	Complete Door Kit
3' x 7'	\$141.00	8 1/4"	\$100.00	\$284.00
3' x 7'	\$141.00	6 1/4"	\$98.00	\$282.00
3' x 7'	\$141.00	4 1/4"	\$93.00	\$277.00
4' x 7'	\$195.00	8 1/4"	\$105.00	\$349.00
4' x 7'	\$195.00	6 1/4"	\$101.00	\$345.00
4' x 7'	\$195.00	4 1/4"	\$99.00	\$343.00
6' x 7'	\$298.00	8 1/4"	\$117.00	\$497.50
6' x 7'	\$298.00	6 1/4"	\$112.00	\$492.50
6' x 7'	\$298.00	4 1/4"	\$110.00	\$490.50

(For Half Glass Add \$82.00 for 3', \$95.00 for 4'; For Vertical Glass Add \$82.00)

## Thresholds

3' .....	\$14.00
4' .....	\$20.00
6' .....	\$28.00

## Locksets

Standard .....	\$17.00
----------------	---------

## Weld On Hinges

3" x 3" .....	\$1.60
4" x 4" .....	\$2.75

## Horizontal Sliding Windows w/Half Screen

3' x 3' .....	\$115.95
4' x 3' .....	\$135.95
6' x 3' .....	\$147.95

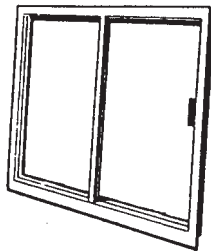

## Screw-On Hinges

4 1/2" x 4 1/2" .....	\$12.00
-----------------------	---------

## Misc.

Oil Operated Door Closer .....	\$75.00
--------------------------------	---------

8" Surface Bolt for Double Door .....	\$13.55/ea.
--	-------------

# Trim

**(SNY-1)**  
**Ridge Roll**

White & Galv.	1.60 ft.
Other Colors	1.92 ft.
Kynar	2.39 ft.



Stk. 10' 3" & 12' 3"  
(White & Galv. Only)

**(SNY-3)**  
**Sculptured Corner**  
RPN 6 1/2" X 6 1/2"

White & Galv.	2.15 ft.
Other Colors	2.75 ft.
Kynar Colors	3.06 ft.



Stk. 10' 3", 12' 3"  
(White & Galv. Only)

**(SNY-5)**  
**Economy Eave**

White & Galv.	.90 ft.
Other Colors	1.15 ft.
Kynar Colors	1.50 ft.



Stk. 10' 3" & 12' 3"  
(White & Galv. Only)

**(SNY-7)**  
**Sculptured Rake**

White & Galv.	2.50 ft.
Other Colors	3.00 ft.
Kynar Colors	3.97 ft.

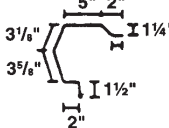

Stk. 10' 3", 12' 3"  
(White & Galv. Only)

**(MT-722 & MT-822)**  
**2" X 2" Outside Angle**

White & Galv.	.90 ft.
Other Colors	1.15 ft.
Kynar Colors	1.50 ft.

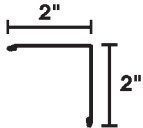

Special Orders Only

**(MT-733 & MT-833)**  
**3" X 3" Angle Trim**

White & Galv.	1.00 ft.
Other Colors	1.25 ft.
Kynar Colors	1.60 ft.

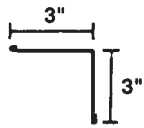

Special Orders Only

**(MT-744 & MT-844)**  
**4" X 4" Angle Trim**

White & Galv.	1.10 ft.
Other Colors	1.35 ft.
Kynar Colors	1.70 ft.

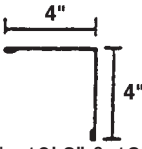

Stk. 10' 3" & 12' 3"  
(White & Galv. Only)

**(SNY-4)**  
**Door Track Cover**

White & Galv.	1.30 ft.
Other Colors	1.62 ft.
Kynar Colors	2.12 ft.

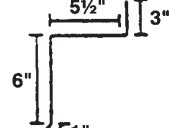

Special Orders Only

**Flat Sheets**

White & Galv.	§38.50 ea.
Other Colors	§46.25 ea.
Kynar Colors	§60.00 ea.

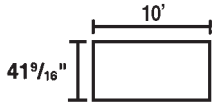

**(SNY-14)**  
**House Rake**  
RPN

White & Galv.	1.60 ft.
Other Colors	1.92 ft.
Kynar Colors	2.34 ft.

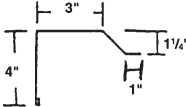

Stk. 10' 3" & 12' 3"  
(White Only)

**(SNY-15)**  
**House Rake**  
UPN

White & Galv.	1.60 ft.
Other Colors	1.92 ft.
Kynar Colors	2.34 ft.

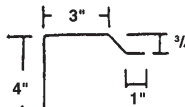

Special Order Only

**(SNY-16)**  
**Valley Flashing**

White & Galv.	2.85 ft.
Other Colors	3.42 ft.
Kynar Colors	4.42 ft.

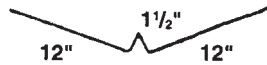

Special Order Only

<p><b>Gutter End Caps</b></p> <table border="0"> <tr><td>White &amp; Galvalume .....</td><td>§5.53 pr.</td></tr> <tr><td>Other Colors .....</td><td>§6.00 pr.</td></tr> <tr><td>Kynar Colors.....</td><td>§7.40 pr.</td></tr> </table> <p><b>45 Degree Kickouts</b></p> <table border="0"> <tr><td>White, Galvalume &amp; Other Colors .....</td><td>§10.80 pr.</td></tr> <tr><td>Kynar Colors.....</td><td>§14.48 pr.</td></tr> </table> <p><b>Sculptured Rake End Caps</b></p> <table border="0"> <tr><td>White, Galvalume &amp; Other.....</td><td>§5.53 pr.</td></tr> <tr><td>Other Colors .....</td><td>§6.00 pr.</td></tr> <tr><td>Kynar Colors.....</td><td>§7.40 pr.</td></tr> </table>	White & Galvalume .....	§5.53 pr.	Other Colors .....	§6.00 pr.	Kynar Colors.....	§7.40 pr.	White, Galvalume & Other Colors .....	§10.80 pr.	Kynar Colors.....	§14.48 pr.	White, Galvalume & Other.....	§5.53 pr.	Other Colors .....	§6.00 pr.	Kynar Colors.....	§7.40 pr.	<p><b>Gutter Strap</b></p> <table border="0"> <tr><td>White or Galvalume .....</td><td>§1.00 ea.</td></tr> <tr><td>Other Colors .....</td><td>§1.25 ea.</td></tr> <tr><td>Kynar Colors.....</td><td>§1.50 ea.</td></tr> </table> <p><b>Downspout Straps</b></p> <table border="0"> <tr><td>White or Galvalume .....</td><td>95¢ ea.</td></tr> <tr><td>Other Colors .....</td><td>§1.07 ea.</td></tr> <tr><td>Kynar Colors.....</td><td>§1.22 ea.</td></tr> </table>	White or Galvalume .....	§1.00 ea.	Other Colors .....	§1.25 ea.	Kynar Colors.....	§1.50 ea.	White or Galvalume .....	95¢ ea.	Other Colors .....	§1.07 ea.	Kynar Colors.....	§1.22 ea.
White & Galvalume .....	§5.53 pr.																												
Other Colors .....	§6.00 pr.																												
Kynar Colors.....	§7.40 pr.																												
White, Galvalume & Other Colors .....	§10.80 pr.																												
Kynar Colors.....	§14.48 pr.																												
White, Galvalume & Other.....	§5.53 pr.																												
Other Colors .....	§6.00 pr.																												
Kynar Colors.....	§7.40 pr.																												
White or Galvalume .....	§1.00 ea.																												
Other Colors .....	§1.25 ea.																												
Kynar Colors.....	§1.50 ea.																												
White or Galvalume .....	95¢ ea.																												
Other Colors .....	§1.07 ea.																												
Kynar Colors.....	§1.22 ea.																												

Other Profiles, Colors and Lengths Available Upon Request...  
*Prices subject to change without notice*

**(SNY-8 & SNY-9)**

**Door Head & Jamb** RPN  
 White & Galv. .90 ft.  
 Other Colors 1.05 ft.  
 Kynar Colors 1.50 ft.

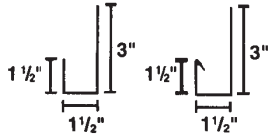

Stk. 7'3", 10'3" & 12'3"  
 (White & Galv. Only)

**(SNY-10 & SNY-11)**

**Door Head & Jamb** UPN  
 White & Galv. .90 ft.  
 Other Colors 1.15 ft.  
 Kynar Colors 1.50 ft.

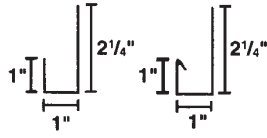

Stk. 7'3", 10'3" & 12'3"  
 (White & Galv. Only)

**(SNY-12)**

**Gutter**

White & Galv. 2.50 ft.  
 Other Colors 3.00 ft.  
 Kynar Colors 3.97 ft.

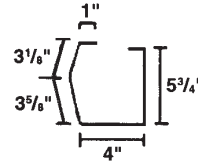

Special Orders Only

**(DS-101)**

**Downspout**

White & Galv. 2.85 ft.  
 Other Colors 3.42 ft.  
 Kynar Colors 4.52 ft.

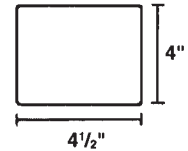

Special Orders Only

**Peak Box**

White & Galv. 9.67 ea.  
 Other Colors 10.80 ea.  
 Kynar Colors 12.97 ea.

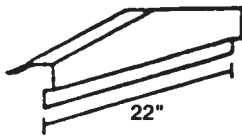

Special Orders Only

**(SNY-17)**

**Transition** RPN

White & Galv. 1.75 ft.  
 Other Colors 2.25 ft.  
 Kynar Colors 2.75 ft.

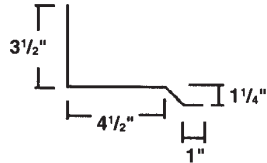

Special Orders Only

**(SNY-18)**

**Transition** UPN

White & Galv. 1.75 ft.  
 Other Colors 2.25 ft.  
 Kynar Colors 2.75 ft.

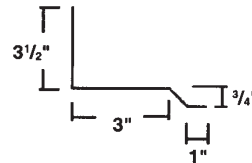

Special Orders Only

**Peak Sheet**

RPN & UPN

White & Galv. 14.50 ea.  
 Other Colors 13.00 ea.  
 Kynar Colors 21.00 ea.

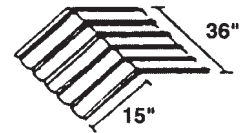

Special Orders Only

Die Form Flashing

10' 5" R or U Panel

White or Galvalume+ \$50.00 ea.

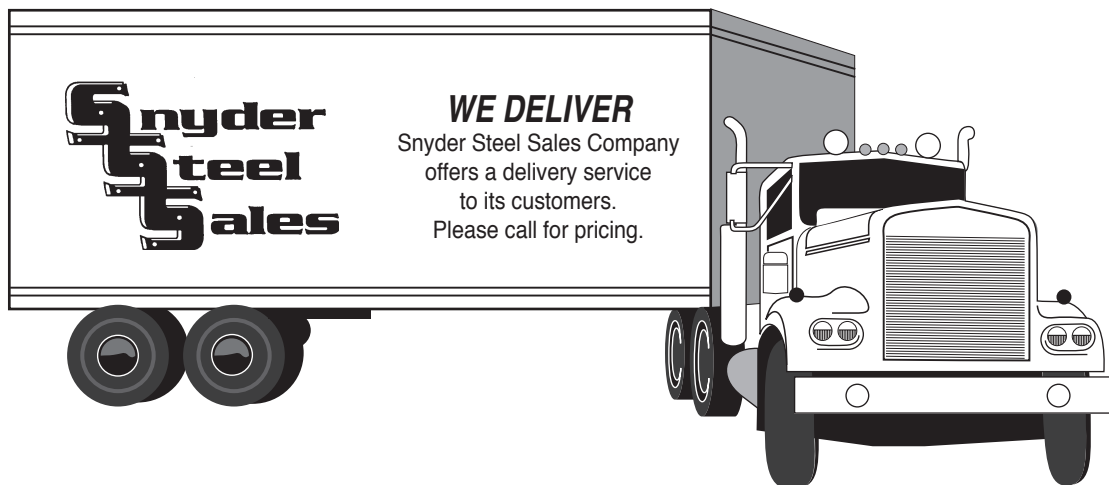

**Metal Building Insulation**

(“R” Factor = 10)

72” x 3” x 50’ .....	\$132.00
Double-sided Tape .....	\$13.00
Fiber Reinforced Patch Tape .....	\$20.75

**Sheetmetal Closures**

Inside or Outside “R” Panel .....	75¢ ea.
Inside or Outside “U” Panel .....	75¢ ea.
25’ X 1½” Foam Sealer .....	\$3.75 ea.
Inside or Outside Sturdi-Rib .....	\$1.17 ea.
<b>With Adhesive</b>	
Inside or Outside “R” Panel .....	85¢ ea.
Inside or Outside “U” Panel .....	85¢ ea.
Low Profile Ridge Venting “R” Panel .....	\$5.50 ea.
Low Profile Ridge Venting “U” Panel .....	\$5.50 ea.

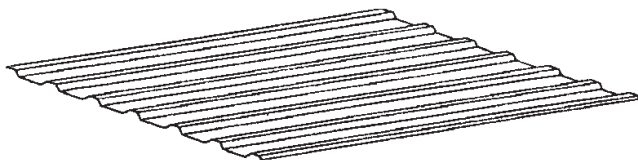

**Skylight**

“R” Panel 8 oz. 12’ .....	\$55.75 ea.
“U” Panel 8 oz. 12’ .....	\$55.75 ea.
Sun Sky Clear or White .....	\$53.00 ea.

(Acrylic has a 10 year warranty against color change and fiber bloom)

**Quick Bolts**

¾” x 3” Wedge Anchor .....	55¢ ea.
¾” x 5” Wedge Anchor .....	95¢ ea.
½” x 4½” Wedge Anchor .....	\$1.25 ea.
⅝” x 6” Wedge Anchor .....	\$1.35 ea.
¾” x 4½” Wedge Anchor .....	\$2.79 ea.
½” x 12” Hook Anchor .....	\$1.50 ea.
⅝” x 12” Hook Anchor .....	\$2.85 ea.
¾” x 12” Hook Anchor .....	\$4.50 ea.

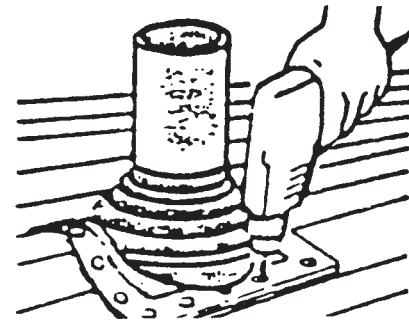

**Masterflash**

#2 (1¼”-3”) .....	\$9.75 ea.
#3 (¼”-4”) .....	\$11.00 ea.
#5 (4”-7”) .....	\$16.50 ea.
#6 (5”-9”) .....	\$27.50 ea.
#8 (7”-13”) .....	\$50.95 ea.
#101 (Retro-fit) (¼”-4”) .....	\$41.50 ea.
#201 (Retro-fit) (4”-9¼”) .....	\$79.00 ea.

**Pop Rivets**

Painted  
08¢ ea.  
1000 pcs. per box

**Drive Pins**

¼” x 1¼” Nail In Anchor .....	20¢
-------------------------------	-----

**Rope Sealer**

½” x ⅜” x 45’ .....	\$2.70
---------------------	--------

**Nutsetters**

¼” .....	\$2.50 ea.
⅝” .....	\$2.75 ea.
¾” .....	\$3.00 ea.
#2 x ⅝” Phillips Bit .....	\$1.50 ea.

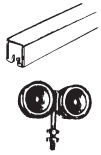

## Sliding Door Hardware

10' Small Rail.....	\$2.90 ft.
12' Small Rail.....	\$2.90 ft.
16' Small Rail.....	\$2.90 ft.
20' Small Rail.....	\$2.90 ft.
24' Small Rail.....	\$2.50 ft.
10' Round Rail.....	\$3.50 ft.
24' Round Rail.....	\$3.15 ft.
Small Rollers.....	\$29.90 ea.
Round Rollers.....	\$35.67 ea.
Small Brackets.....	\$3.50 ea.
Round Brackets.....	\$4.00 ea.
Round Splice Bracket.....	\$6.25 ea.
Small Splice Bracket.....	\$5.75 ea.
4" Cast Iron V Groove Wheel.....	\$35.00 ea.
6" Cast Iron V Groove Wheel.....	\$55.00 ea.

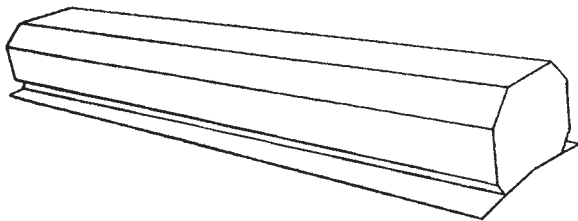

## Ridge Vents

White & Galvalume

10' Continuous Vent with 9" Throat

Bird Screen Damper:

Flat Skirt.....	\$329.00
Die Form Skirt.....	\$329.00
10' Low Profile.....	\$185.00
End Caps.....	\$16.50 pr.
Low Profile Splice Kits.....	\$14.25 ea.
20" Round w/Damper.....	\$196.00

## Caulk

Clear.....	\$5.95
White.....	\$5.95

## Roll-Up Doors

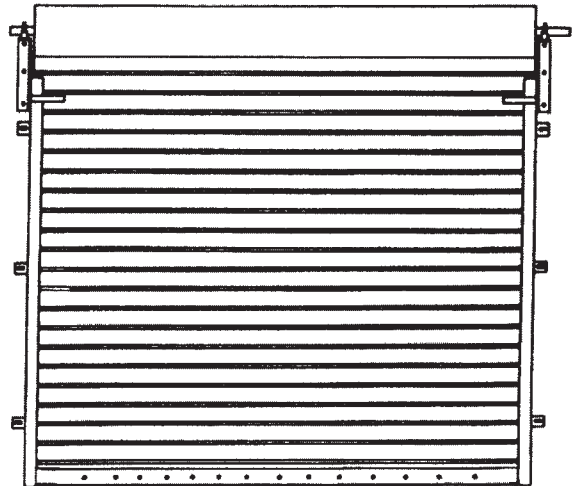

Porvene

4' x 7' Mini Door.....	\$237.00
8' x 8' Mini Door.....	\$363.00
9' x 7' Mini Door.....	\$380.00
10' x 8' Mini Door.....	\$418.00
10' x 10' Mini Door.....	\$506.00

### Porvene Commercial Doors

10' x 10' Commercial Model 211.....	\$737.00
10' x 12' Commercial Model 211.....	\$891.00
12' x 10' Commercial Model 211.....	\$902.00
12' x 12' Commercial Model 211.....	\$979.00
12' x 14' Commercial Model 211.....	\$1172.00
14' x 14' Commercial Model 231.....	\$1,634.00

OTHER SIZES AVAILABLE  
UPON REQUEST

## Paints

Red

1 Gal.....	\$20.50 ea.
5 Gal.....	\$90.50 ea.

Touchup Paint

Per can.....	\$10.25
--------------	---------

# Power Tools & Fence Supplies



## Power Tools

- Hitachi Screwgun..... \$149.50
- Kett Power Shear ..... \$157.75
- 14" Cut-off Blades..... \$9.25
- Blades for Kett Shear ..... \$35.00
- Kett Nibbler Attachment..... \$94.00
- Die & Punch Kit for Nibler..... \$42.00

## Galvanized Livestock Panels

- 34" X 16' X 4 ga..... Hog ..... \$24.50
- 52" X 16' X 4 ga..... Cattle..... \$25.50
- 48" X 20' X 6 ga..... 4" x 4" ..... \$36.76
- 60" X 20' X 6 ga..... 4" x 4" ..... \$45.59

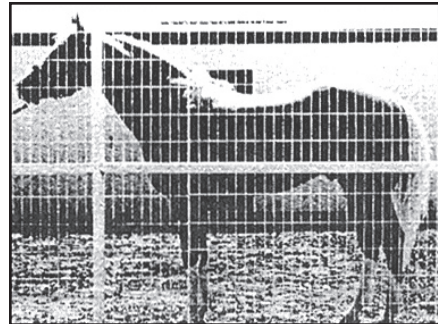

*Prices subject to change without notice*

### **SNYDER STEEL SALES**

164 US Hwy 283 S.  
Seymour, Texas 76380

